

Waarom...

...vormen zonnebloempitten
21 bochten in de ene richting
en **34** in de andere?

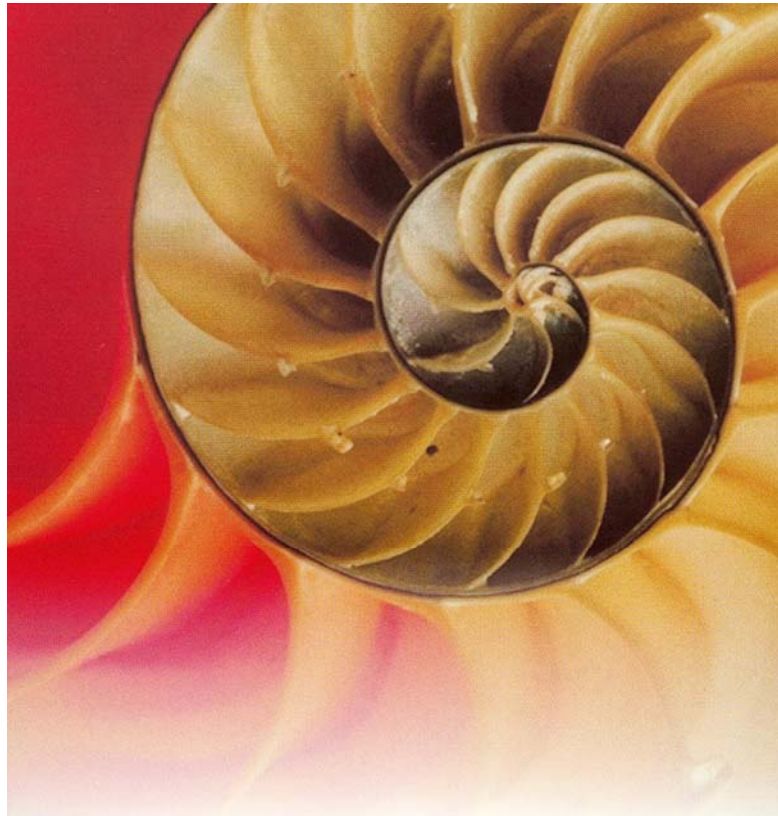

Zoek het verband...

...tussen een huisjesslak
en $(1+\sqrt{5})/2$.

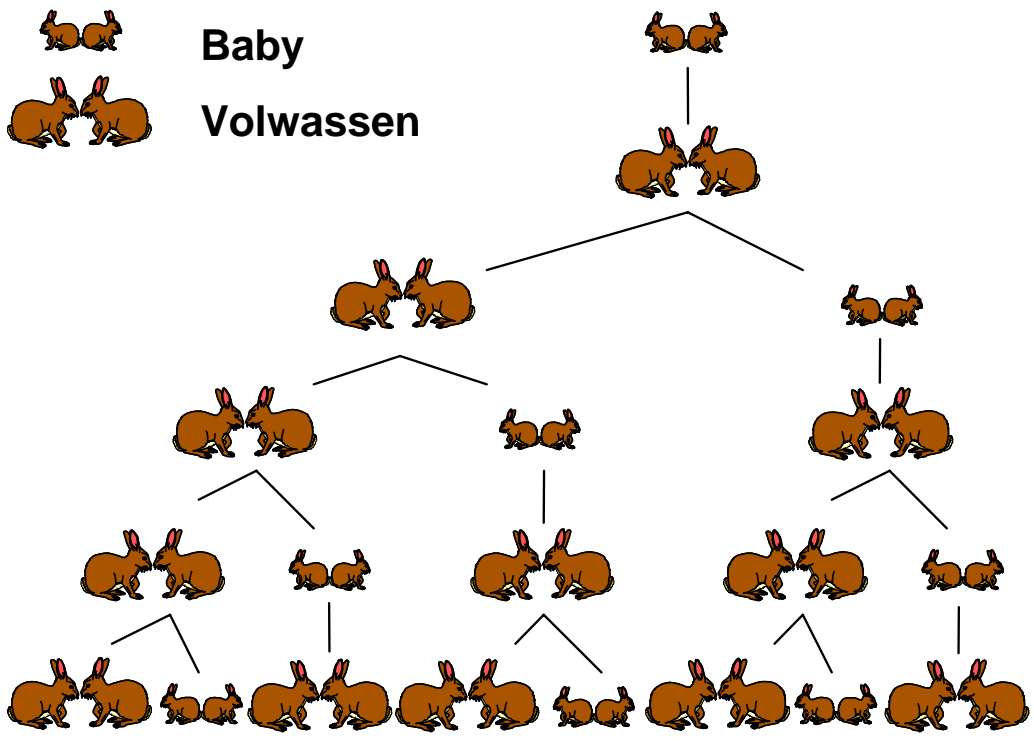

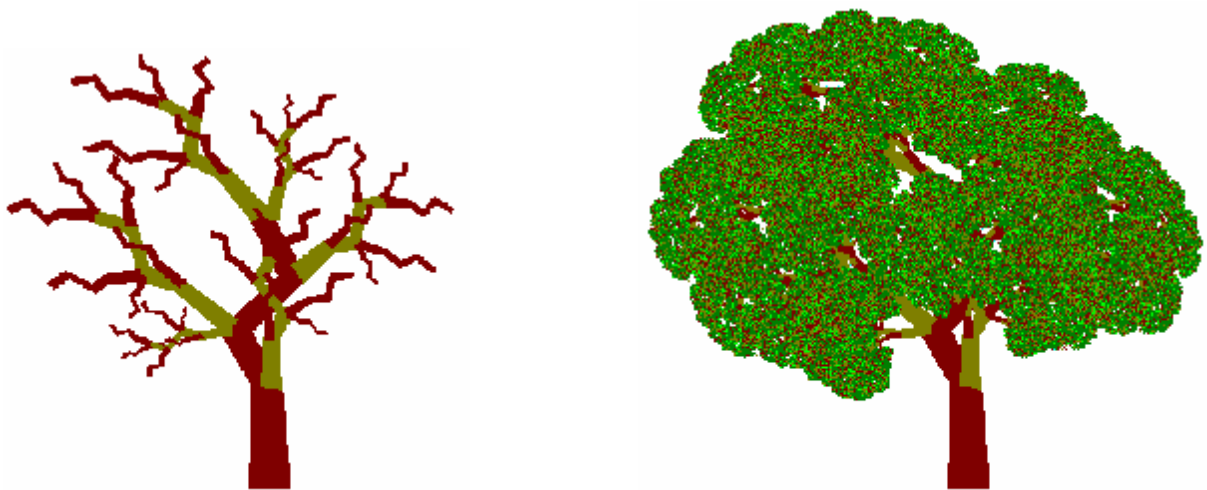
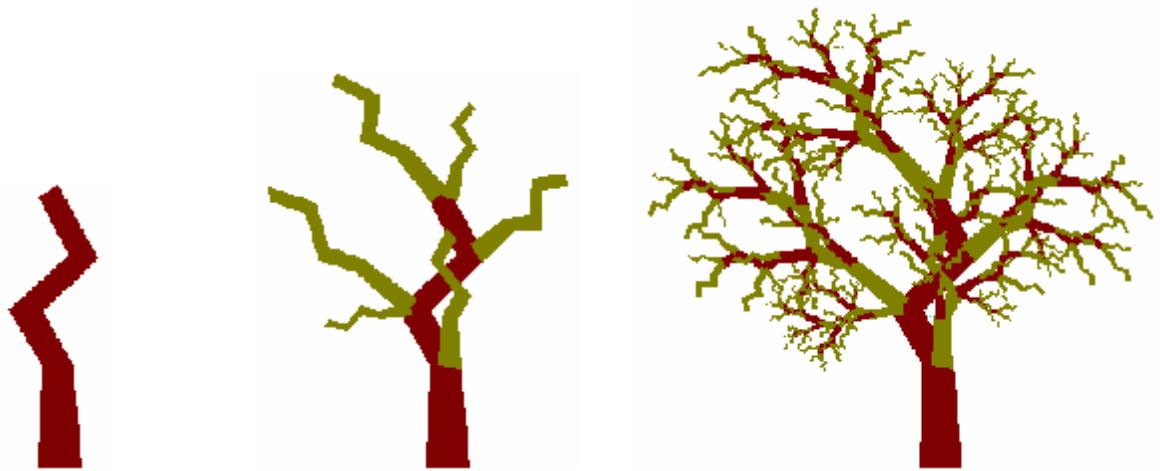

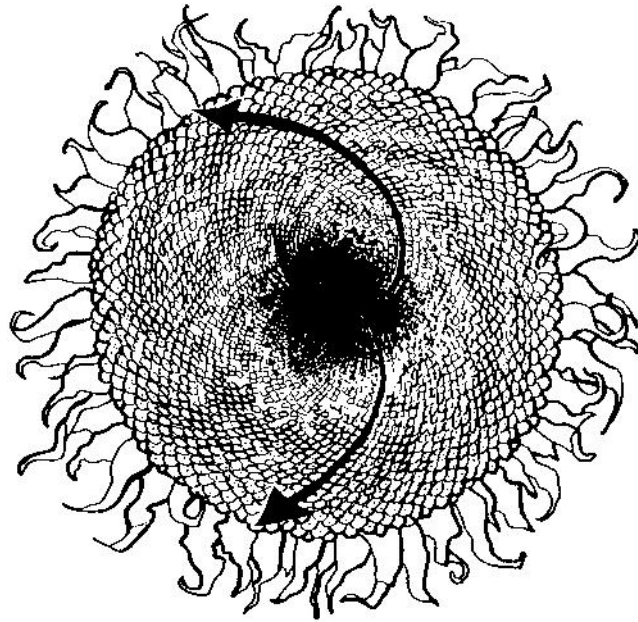

8



13

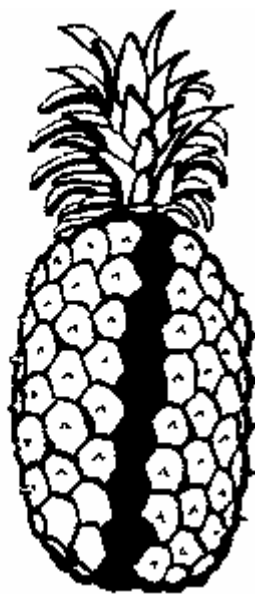

21

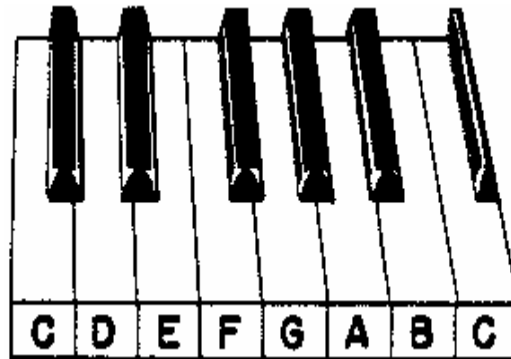

*De vrouw van een deken in Laken
Lag 's nachts diepe zuchten te slaken,
Zij kreunde zacht : 'O !
Het kriebelt mij zo :
Wel een deken in bed, maar geen laken.'*

(Alex van der Heide)

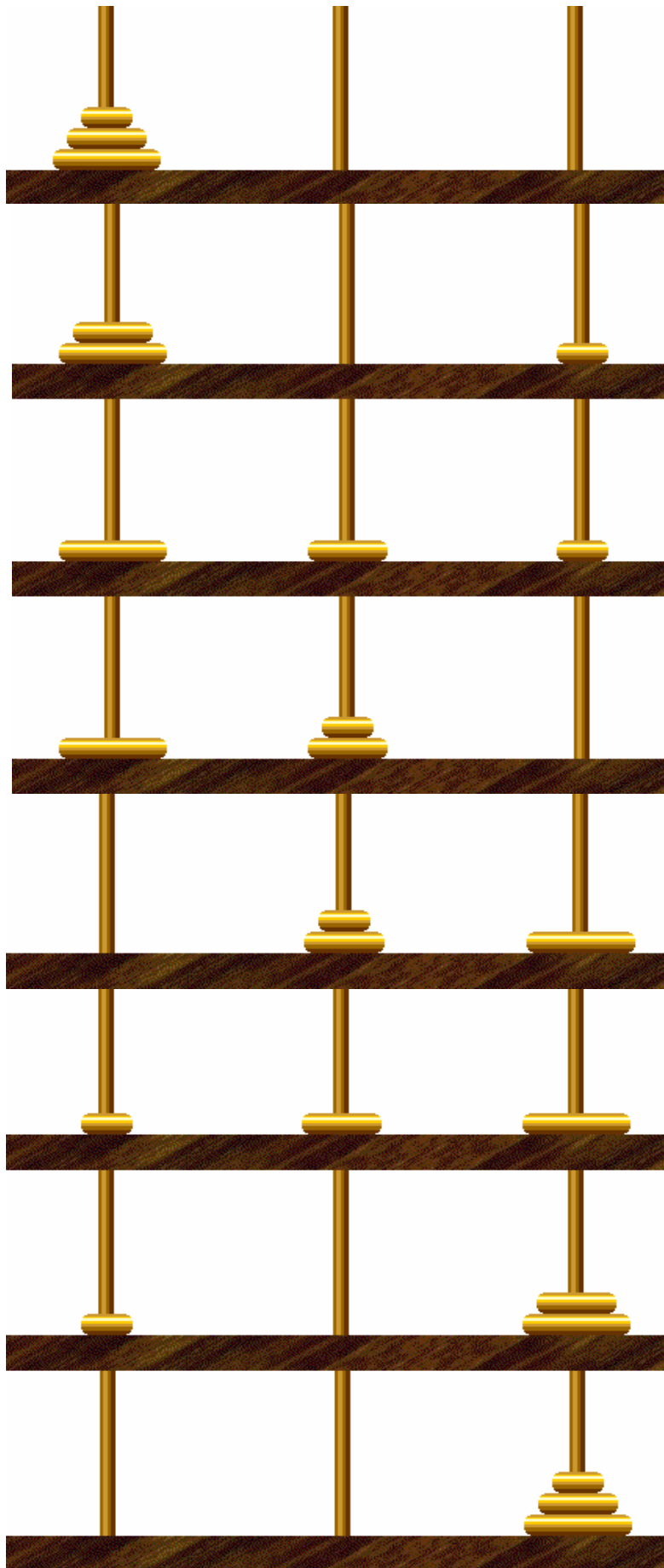

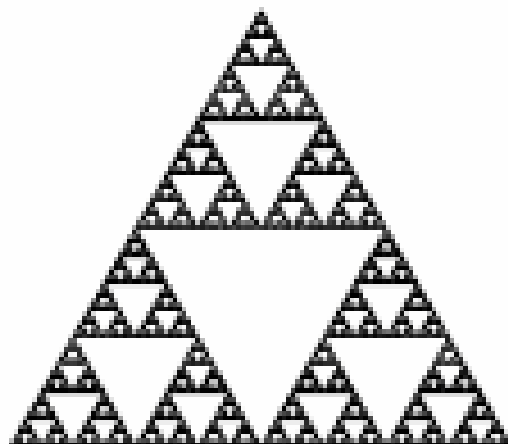
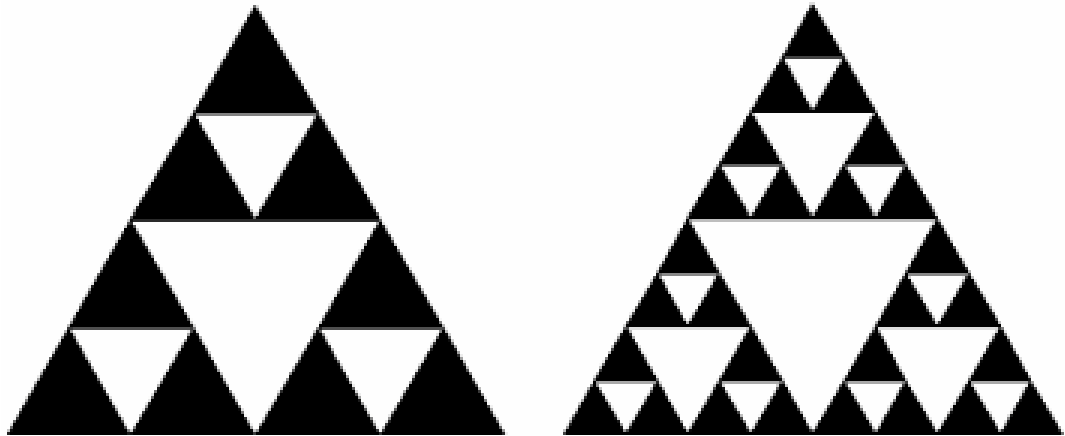
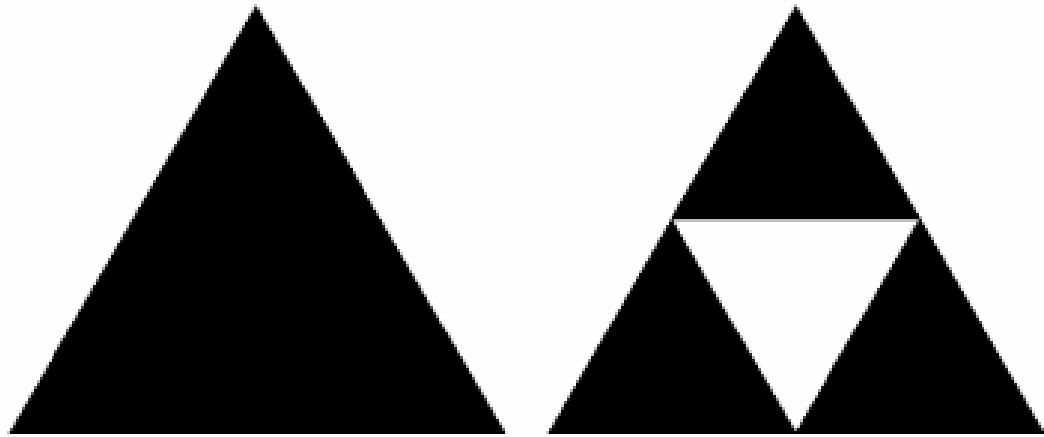

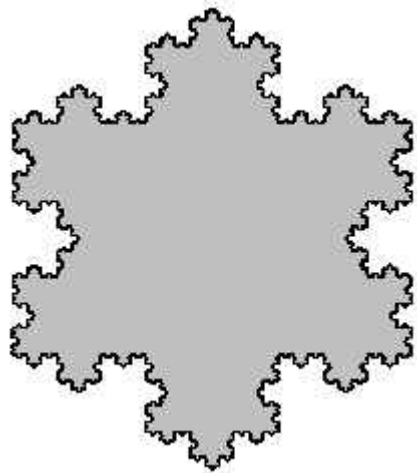
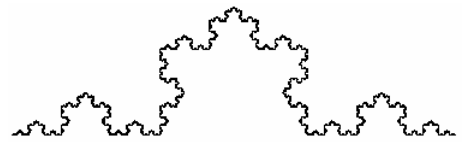
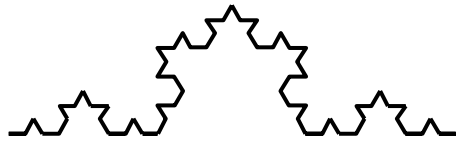
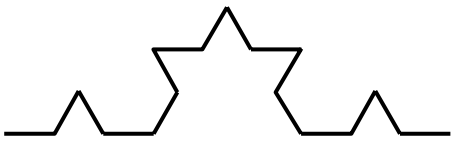
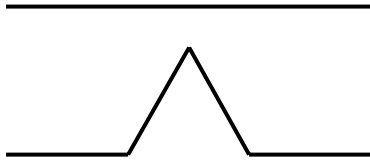

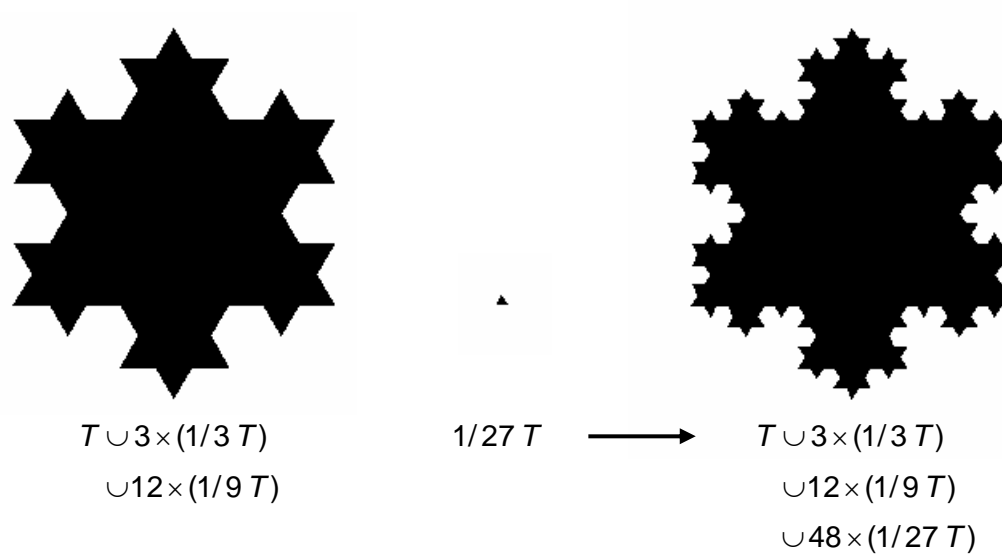
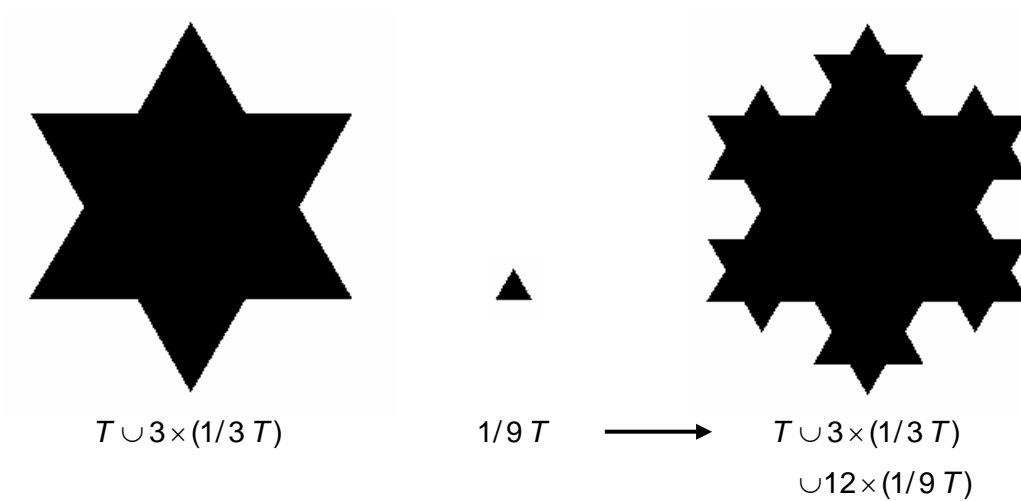
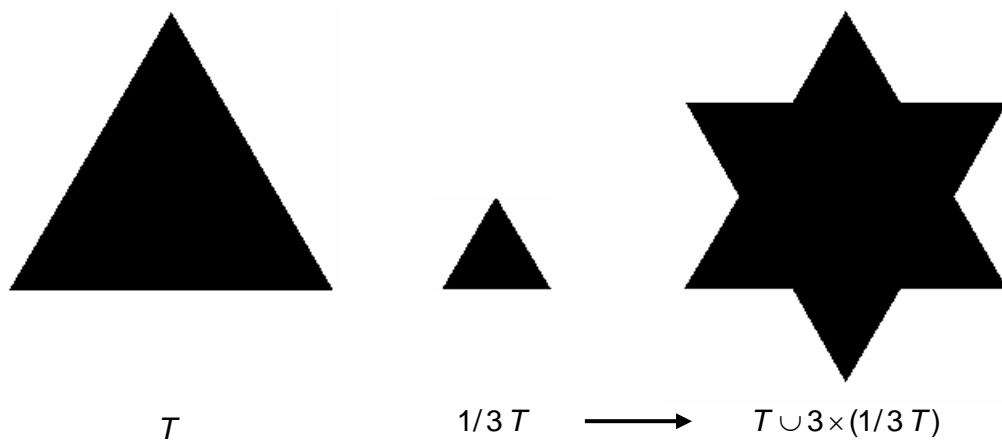

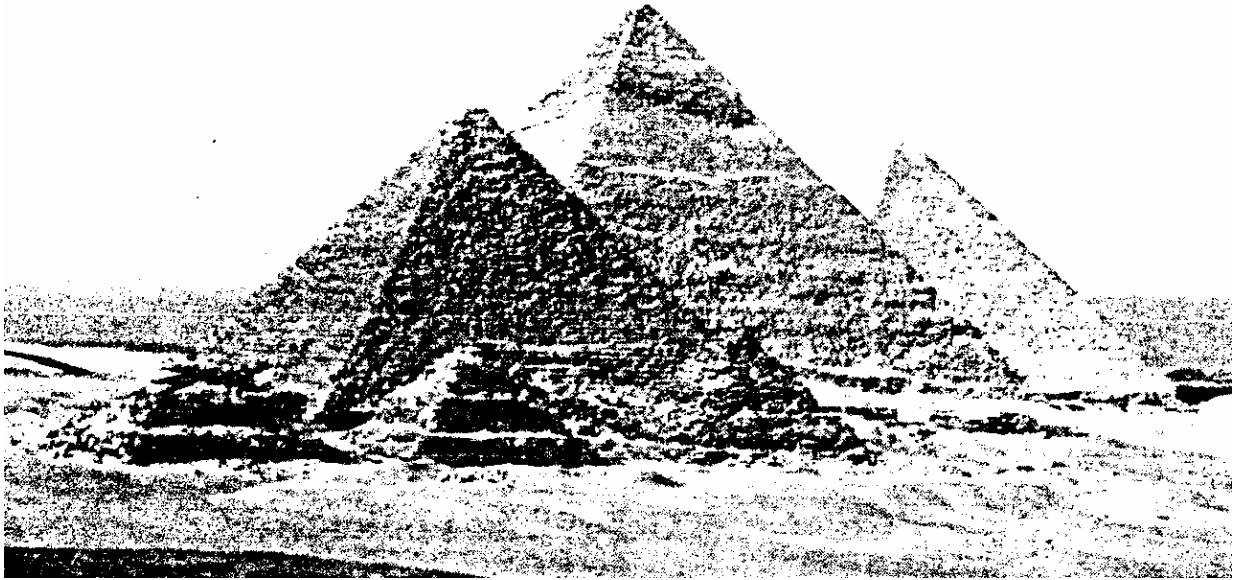

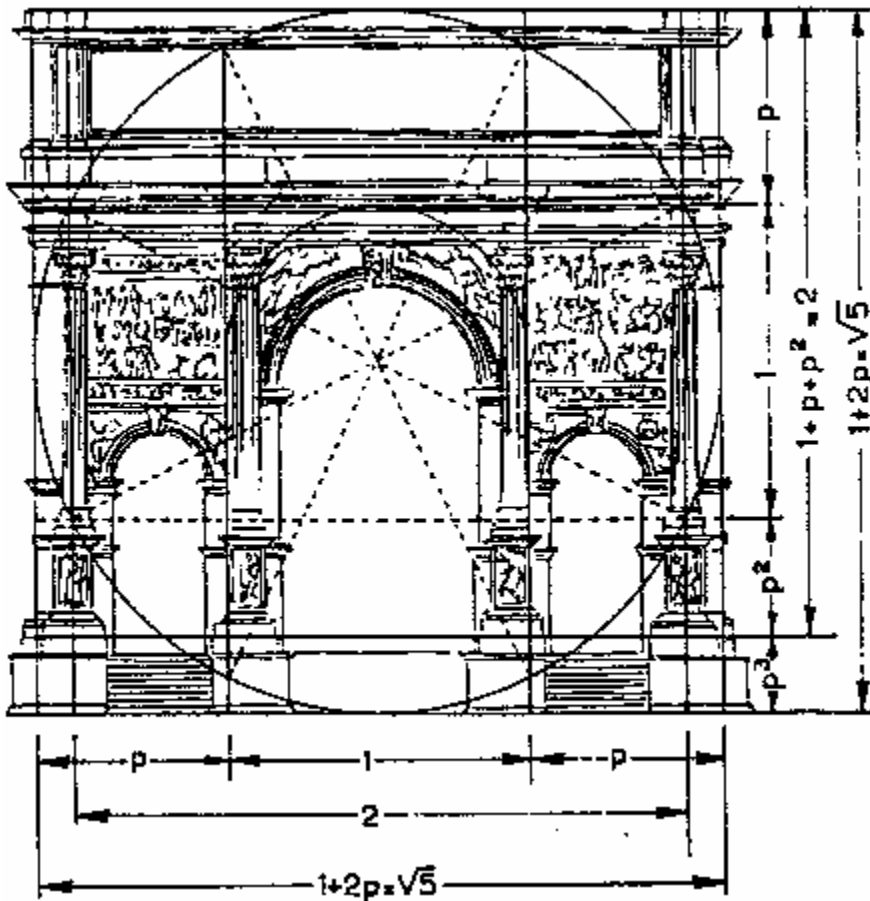

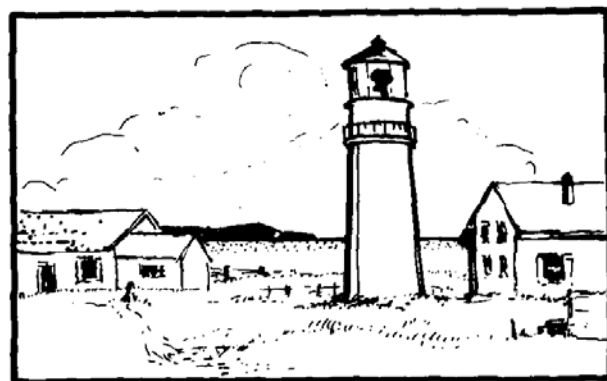
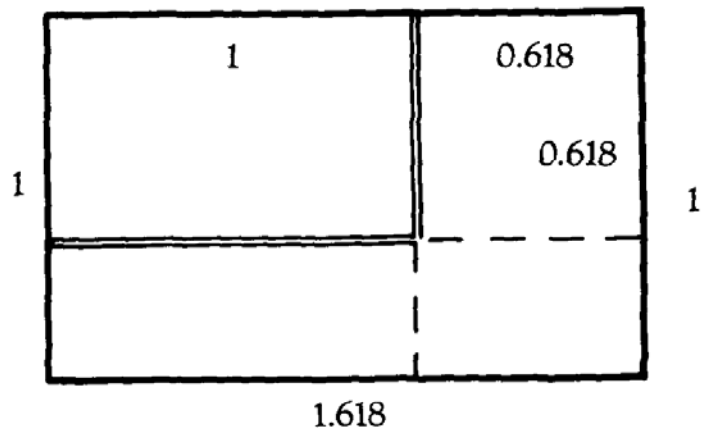
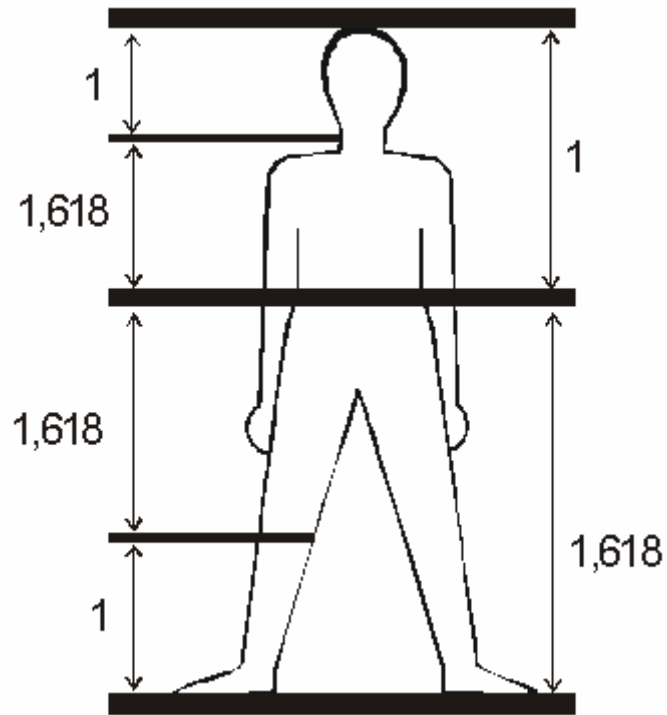

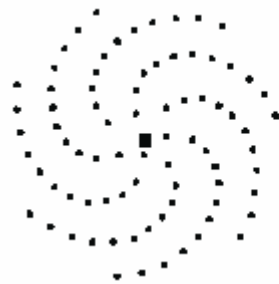
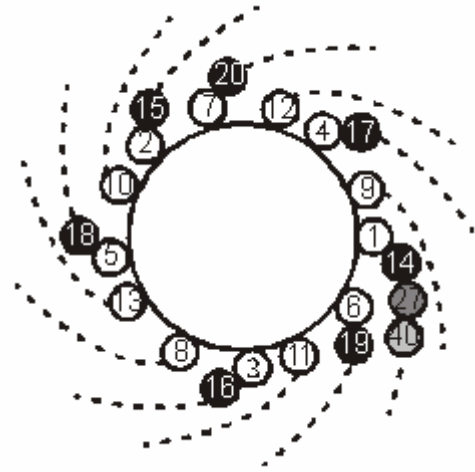
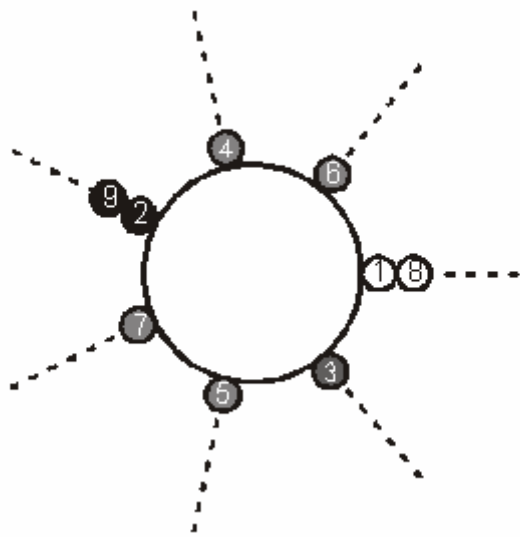

e

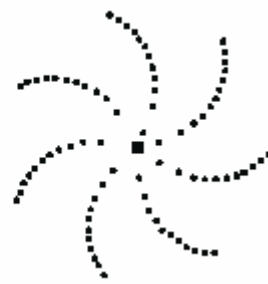

π

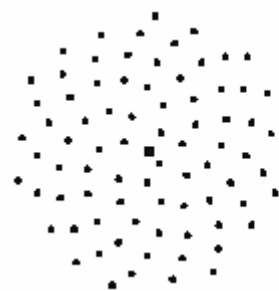

$\sqrt{2}$

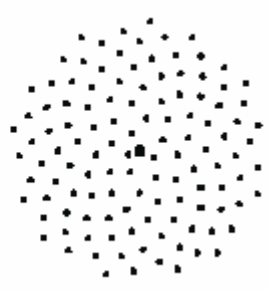

ϕ

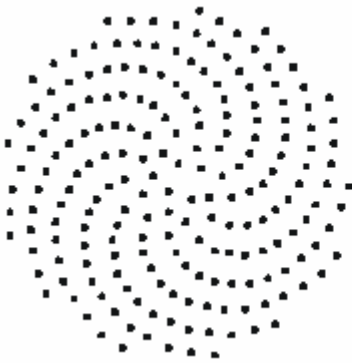

1,617

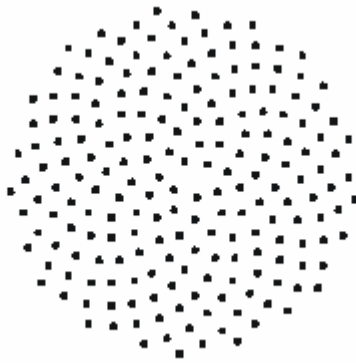

φ

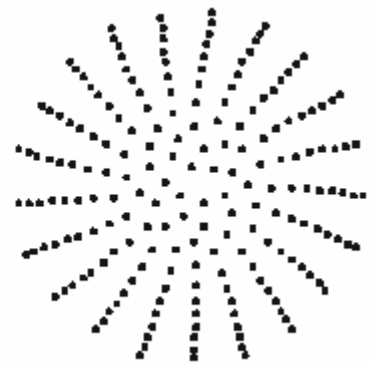

1,619

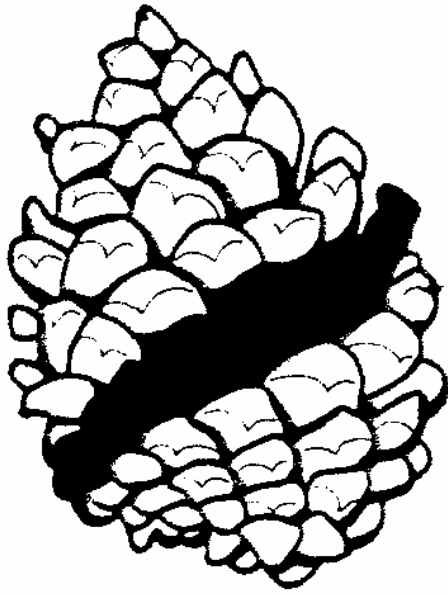

8

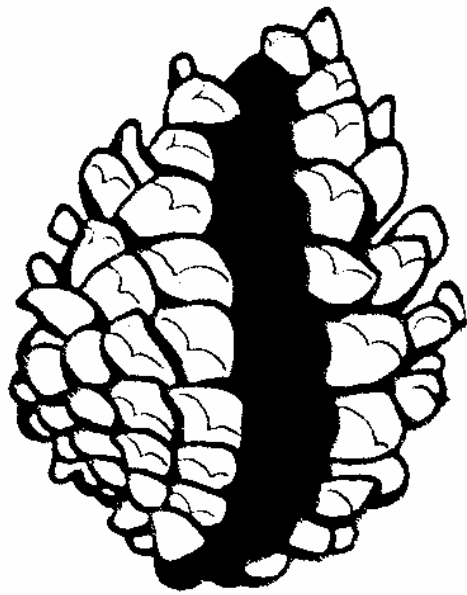

24

